

***USING A SUN DIAL TO MEASURE TIME IS OUT OF DATE!  
WHY DO YOU MEASURE THE MOISTURE OF SAND, GRAVEL AND  
CONCRETE WITH OUTDATED TECHNOLOGY?***

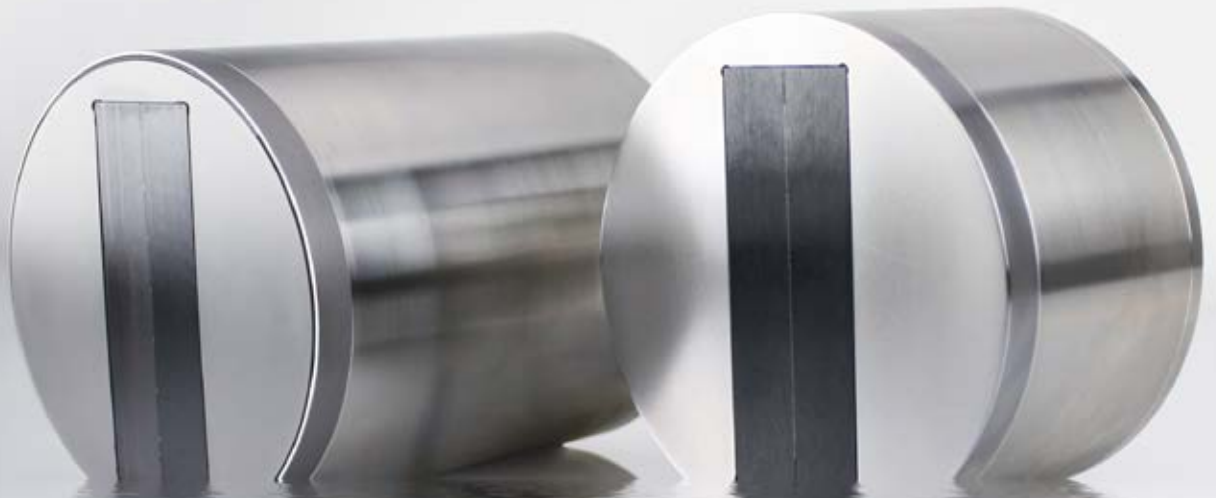

***MOISTURE PROBES FOR THE CONCRETE INDUSTRY***



**Simply the better method to measure!**

# **OUTDATED MOISTURE PROBES COST YOU MONEY!**

Anyone involved with the concrete industry is well aware of the problems connected with the production of cement. The main issue is that it is difficult to control and that there is consequently always a risk of ending up with non-acceptable results which cost dearly. Complicated calibration processes for individual recipes, laborious recalibration after only short periods due probe wear, incorrect added water quantities – all these factors cost time and money.

Due to the innovative TRIME® radar technology, it is finally possible for the first time ever, to eliminate the disadvantages and problems of all previous moisture probes. The SONO-MIX now enables the long-term stable measurement of your concrete directly in the mixer without the necessity of any further recalibrations. Coarse aggregate can contain a lot of water which in turn may lead your water calculation to be wrong. This is why a precise measurement of the moisture content is so important! Now, for the first time ever you are now able to measure coarse aggregates reliably over many years from size 1...32mm, whether gravel or grit. All SONO probes can easily be integrated to update or upgrade any PLC, respectively control system.

**FEEL FREE TO COMPARE THE PERFORMANCE DATA WITH ANY OTHER PROVIDERS ON THE MARKET! CHANGE TO A TOTALLY NEW DIMENSION OF MOISTURE MEASUREMENT AT A LEVEL OF ACCURACY YET UNKNOWN THAT WILL ALSO ENABLE YOU TO PERFORM TOTALLY NEW APPLICATION OPTIONS.**

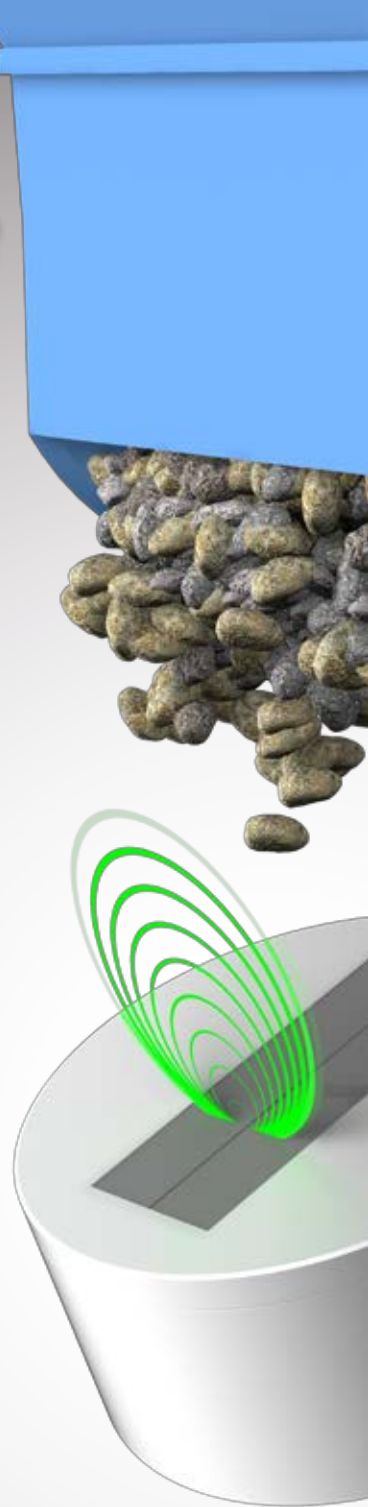

The SONO probe series stands out with an **ATTRACTIVE COST-TO-PERFORMANCE RATIO.**



**MEASURE THE MOISTURE CONTENT** of any type of sand, as well as gravel and grit with the SONO probes, **REGARDLESS OF THE GRAIN SIZE.**



Representantes / Distribuidores Exclusivos

 Argentina

Tel: (+54 11) 5352 2500

Email: [info@dastecsrl.com.ar](mailto:info@dastecsrl.com.ar)

Web: [www.dastecsrl.com.ar](http://www.dastecsrl.com.ar)

 Uruguay [www.dastecsrl.com.uy](http://www.dastecsrl.com.uy)

 Paraguay [www.dastecsrl.com.py](http://www.dastecsrl.com.py)

 Bolivia [www.tecdas.com.bo](http://www.tecdas.com.bo)



SONO-probes **ELIMINATE** the necessity for **EXPENSIVE EVALUATING DEVICES**, which many other probes require. The necessary “intelligence” is already integrated into the SONO-probes.



**EASY INITIAL COMMISSIONING, SIMPLE INSTALLATION**, and then just connect – you are ready to go. Laborious calibration is a thing of the past.



**EXTREMELY DURABLE**, the probe even withstands exposure to 32mm gravel falling from great heights.



Due to the unique **INTEGRATED AUTO-CORRECTION FUNCTION**, SONO probes recalibrate themselves in the event of abrasion at the probe head. This means savings in terms of time and costs at the maintenance of 90%!

# INCREASE THE LEVEL OF SAFETY AND REDUCE DAMAGE-RELATED COSTS DUE TO NOVEL MEASURING METHODS AT THE QUALITY CONTROL

## SONO-PROBES DEPLOY THE EXCEPTIONAL TRIME® RADAR METHOD

The SONO TRIME®-technology consists of a „guided radar wave“ which travels along a radar track at almost the speed of light. Subsequently, the measuring field spreads out above the probe discoidal form into the material. The measuring field of SONO probes is also operational even at lower material heights above the probe (within certain limits of course). If the material above the probe features a greater height, respectively quantity, the measuring field will also penetrate into the larger material volume. Any influences to the measuring field, e.g. due to individual larger grains, or fines content are quasi compensated by this technology and any further influences caused by plant-specific components are respectively minimized.

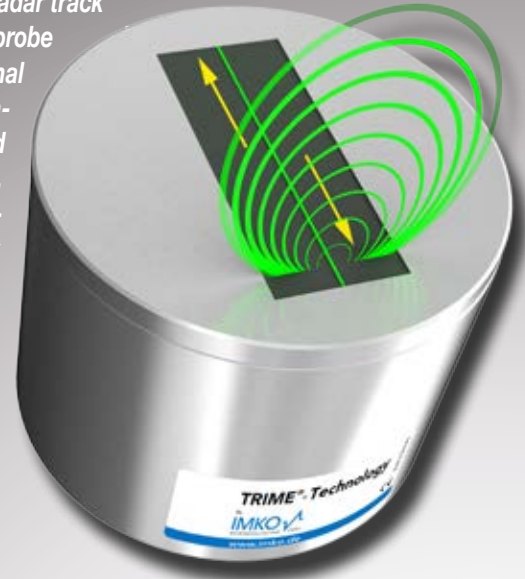

## THE SONO-PROBE AS A MOISTURE “TOMOGRAPH”

The diagram shows the SONO-VARIO Xtrem with an exchangeable probe head made of hardened steel with special ceramic plate which even withstands exposure to 32mm gravel falling from great heights. Similar to a CT, the material is measured layer by layer in discoidal form.

## “SMART” PROBE HEADS

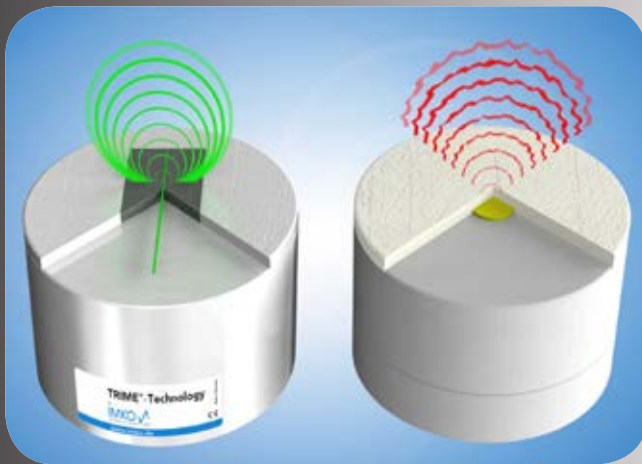

Moisture probes typically use a ceramic covering which causes failures due to abrasion leading to deviations of several percent. At conventional older moisture probes, the electrical field lines have to pass the ceramic covering before they can penetrate into sand and gravel. Even in the event of minor abrasion, the electrical field alters and therefore may lead to considerable errors that may amount to several percent deviations.

At the SONO radar technology, an innovative probe head construction with a centered guided radar conductor foil ensures that the electrical field intensity does not change, even in the event of abrasion. An automatic integrated measurement compensation function warrants for consistent and precise measurement results and enables significant longer operating periods without the necessity of recalibration.

**CONSEQUENTLY, YOU SAVE UP TO 90% MAINTENANCE COSTS IN COMPARISON TO OLDER CONVENTIONAL MOISTURE PROBES.**

## SEEING WHAT IS GOING ON

The installation of a moisture probe directly into a silo has the big disadvantage that, in the event the material is stationary and there is no flow, sand can stick and bake on the probe's surface. As the plant operator is then prevented from visually controlling this formation of deposits and the processing in general, this may lead to uncertainties and negatively influence quality.









Our recommendation for the best installation location for moisture probes is under a silo flap which automatically warrants for ideal self-cleaning of the probe's surface in the course of the processing itself. SONO probes are extremely durable and even withstand exposure to large gravel falling from great heights.



# DECISIVE FACTORS TO ACHIEVE PRECISE RESULTS IN CONCRETE PRODUCTION

PRACTICE HAS PROVEN AGAIN AND AGAIN THAT THE CORRECT INSTALLATION OF MOISTURE PROBES PLAYS A SIGNIFICANT ROLE. THIS FACTOR SHOULD NOT BE UNDERESTIMATED IN TERMS OF ACHIEVING LONG-TERM STABLE RESULTS FOR CONCRETE RECIPES USING AGGREGATE MOISTURE PROBES WITH AN ACCURACY OF  $\pm 2$  LITER WATER PER  $M^3$  CONCRETE.

THE FOLLOWING FACTORS AND PROBE CHARACTERISTICS MUST BE CONSIDERED TO ACHIEVE PRECISE RESULTS:

-  **VARIATIONS IN THE GRAIN SIZE DISTRIBUTION** (e.g. broken or polished sand) can cause considerable measured-value fluctuations of conventional moisture probes within in ranges of  $\pm 1.5\%$  or  $\pm 15$  liters per  $m^3$ .
-  The moisture of **ROUGH AGGREGATES** can not be measured with conventional moisture probes, although these may contain up to 25 liters of water per  $m^3$ .
-  An **ABRASION OF THE MOISTURE PROBE'S** surface can lead to considerable inaccuracies of several percent deviation within a short period.
-  **FINE PARTICLES IN AGGREGATES** can lead to inaccuracies that may amount to several percent. The higher the content of fine particles, the less probable it is for conventional moisture probes to perform an accurate measurement.
-  Considerable dependencies can be caused by **FLUCTUATING BULK HEIGHTS** above the moisture probe. Conventional moisture probes have often to be installed in non-ideal installation places, e.g. inside a silo or inside the outlet.
-  When **PRODUCING PARTIAL QUANTITIES** of concrete, the exposure of the probe to the individual batches can be very short so that conventional moisture probes cannot measure correctly. Moisture probes should be able to distinctively detect the start and the end of a batch sequence.
-  **TEMPERATURE AND DIFFERENT MINERAL CONTENTS** can cause measurement fluctuations.
-  **FEEL FREE TO COMPARE THE PERFORMANCE DATA WITH ANY OTHER PROVIDERS ON THE MARKET! CHANGE TO A TOTALLY NEW DIMENSION OF MOISTURE MEASUREMENT AT A LEVEL OF ACCURACY AND QUALITIES YET UNKNOWN THAT WILL ALSO ENABLE YOU TO PERFORM NEW APPLICATION OPTIONS WITHIN CONCRETE PRODUCTION.**

## CONTENT CUSTOMERS



AND MANY MORE...

**THE RIGHT SOLUTION FOR ANY INSTA  
SONO PROBES HAVE PROVEN THEY**

**MOISTURE MEASUREMENT OF SAND 0-4mm**

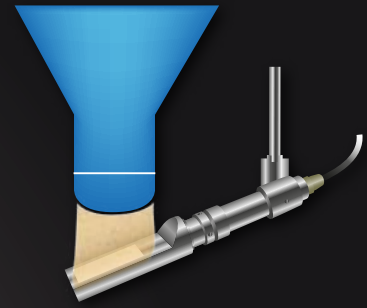
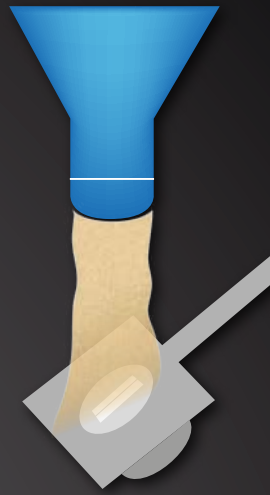
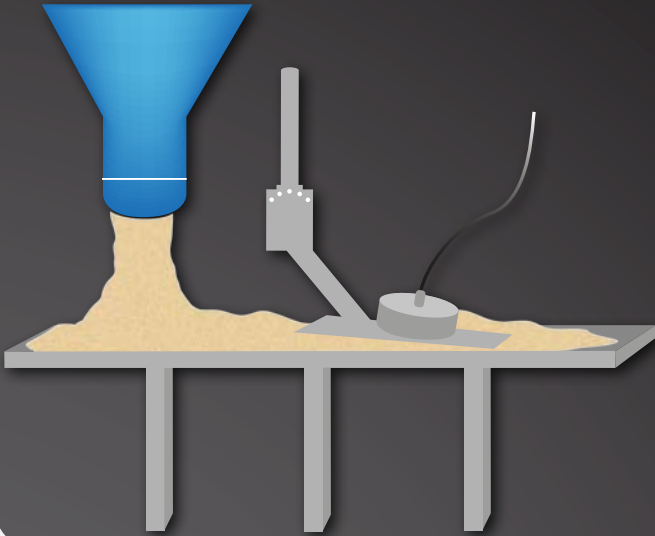

**SONO-VARIO**

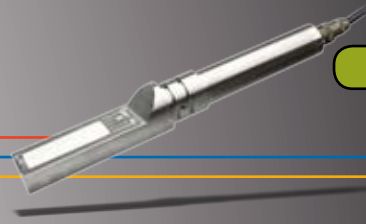

**SONO-SILO**



**EVEN OLDER PLANTS CAN BE OPERATED MORE EFFICIENTLY**

*In older plants where no PLC-technology for water dosing is available, it is possible to control the moisture content of single aggregates with the SONO-VIEW. Regardless whether up to four probes, the display dynamically adapts the digit height and provides high readability even at larger distances. Due to built-in intelligence inside the SONO-VIEW, it is independently capable to detect the Start and the End of a batch sequence and to send control signals to establish the average moisture value of a complete batch and to display the same on the SONO-VIEW.*

**THE USUAL RANDOM MANUAL SAMPLING TO CONTROL THE AGGREGATE MOISTURE IS NO LONGER REQUIRED. THE MANUAL DOSING OF WATER CAN CONSEQUENTLY BE DONE WITH A MUCH HIGHER PRECISION.**



# INSTALLATION SITE AND ANY APPLICATION IMPROVE THE CONCRETE QUALITY

## MOISTURE MEASUREMENT OF GRAVEL AND GRIT 4-32mm



**SONO-VARIO Xtrem**

## MOISTURE MEASUREMENT OF CONCRETE

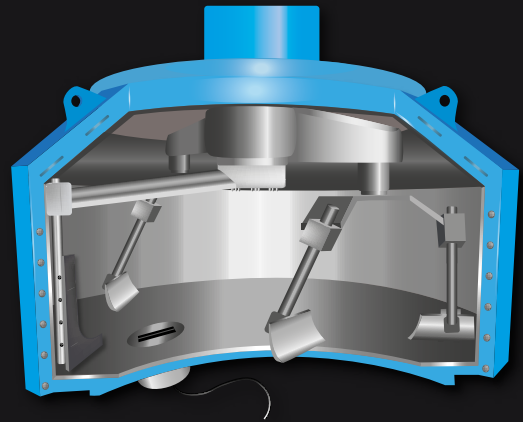

**SONO-MIX**

## VIEW WITH SONO-VIEW!

It is possible to visualize the moisture content of the material. Whether these are only single or multiple probes, these are independent of the application and therefore do not require connection to a computer. Subsequently visualize the

MOISTURE IS NO LONGER  
NEEDS TO BE PERFORMED WITH

## PROBES WHICH OPTIMIZE YOUR APPLICATION

SONO moisture probes can be configured ideally and easily for the individual respective application. Depending on the application, e.g. for moisture measurement under a silo flap, inside a mixer or on a conveyor belt, the SONO probe can be set to an appropriate operating mode. The available operating modes, e.g. single-value measurement, averaging, filtering, the summation of moisture values of a complete batch cycle, setting of limits and other performance-relevant operational parameters powerful functions can be set directly inside the SONO probe itself. An integrated high-capacity microprocessor disposes of all required "intelligence" and already performs all required signal evaluation in the sensor itself.

**AN ADDITIONAL COST-INTENSIVE EXPENSIVE EVALUATING DEVICE IS NOT REQUIRED FOR MOST APPLICATIONS!**



## SONO MOISTURE PROBES – THE SURE WAY TO BETTER CONCRETE!



### SONO-VARIO Standard

SONO-VARIO Standard is ideal for measuring the moisture content of sand and gravel up to a grain size of 4mm. The probe head consists of high grade steel with a rectangular ceramic window.



### SONO-VARIO Xtrem

SONO-VARIO Xtrem is ideal for measuring the moisture content of highly abrasive gravel and grit up to a grain size of 32mm. The exchangeable probe head consists of hardened steel with an integrated highly wear resistant special ceramic window.



### SONO-SILO Standard

SONO-SILO Standard is ideal for the measuring of sand and gravel that features a “normal” abrasion level up to a grain size of 4mm. The exchangeable probe head consists of high grade steel with an inserted rectangular ceramic window.



### SONO-SILO Xtrem

SONO-SILO Xtrem is ideal for the measuring of highly abrasive gravel and grit up to a grain size of 32mm. The exchangeable probe head consists of high grade steel with an inserted highly wear resistant special ceramic window.



### SONO-MIX

The heavy duty mixer probe, designed for hardest deployments in pan-type, ring-trough, planetary or twin-shaft cement mixers. The exchangeable probe head consists of hardened steel reinforced with a massive tungsten carbide plate and an integrated highly wear resistant ceramic window.



### SONO-VIEW

Stand-alone display for the moisture content and configuration tasks for reliable process control with SONO –probes. Up to 4 moisture probes can be connected online via a serial interface.